

# HF HeadlineFilters

## Model: 124 (1/8" NPT)

Replacement Parts List	
12-57-xx	Disposable Filter Element
SS-12-57-xx	Stainless Steel Filter Element
PT-12-57-xx	PTFE Filter Element
TR120	Tie Rod (A)
ER110	Element Retainer (B)
SC120	Support Core (Not Pictured)
SSB 124	316L Stainless Steel Bowl (C)
MB110	Mounting Bracket (Not Pictured)
Oxygen Cleaning Service Available Note – Please replace “xx” with micron rating or grade	
Available O-Rings	
GN110	Nitrile
GV110	Viton (Standard) (D)
KZ110	Kalrez™
GS110	Silicone

\*\*For a Solid PTFE Gasket – Order a 124S\*\*

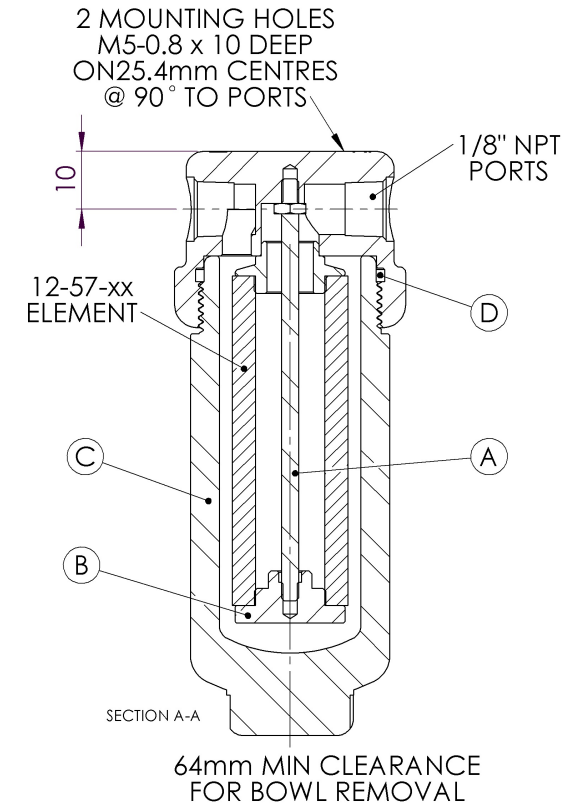

Please Note: Exotic Materials are available, for Alloy C-276 (124H) and for Alloy 400 (124M).

Headline Filters Limited Mill Hall Business Estate Aylesford Kent, ME20 7JZ www.headlinefilters.com info@headlinefilters.com	<b>Model 124</b>		THE COPYRIGHT OF THIS DRAWING IS RESERVED BY HEADLINE FILTERS. IT IS ISSUED ON CONDITION THAT IT IS NOT COPIED, REPRODUCED OR DISCLOSED TO A THIRD PARTY EITHER WHOLLY, OR IN PART WITHOUT CONSENT IN WRITING.
	<b>Material:</b> Head: 316L Stainless Steel Bowl: 316L Stainless Steel Internals: 316L Stainless Steel Standard Gasket / O-ring: Viton	<b>Drain Type:</b> No Drain <b>Maximum Temperature:</b> 200°C <b>Maximum Pressure:</b> 340 BAR <b>Internal Volume:</b> 30 cc <b>Weight:</b> 400g	
<b>DO NOT SCALE DRAWING IF IN DOUBT ASK</b>	<b>Drawing No. HF4/3971</b>		