

HF HeadlineFilters

Model: 142 (1/2" NPT)

Replacement Parts List	
25-178-xx	Disposable Filter Element
SS-25-178-xx	Stainless Steel Filter Element
PT-25-178-xx	PTFE Filter Element
TR140	Tie Rod (A)
ER130	Element Retainer (B)
SC140	Support Core (Not Pictured)
SSB 140	316L Stainless Steel Bowl (C)
MB130	Mounting Bracket (Not Pictured)
Oxygen Cleaning Service Available Note – Please replace "xx" with micron rating or grade	
Available O-Rings	
GN130	Nitrile
GV130	Viton (Standard) (D)
KZ130	Kalrez™
GS130	Silicone

For a Solid PTFE Gasket – Order a 142S

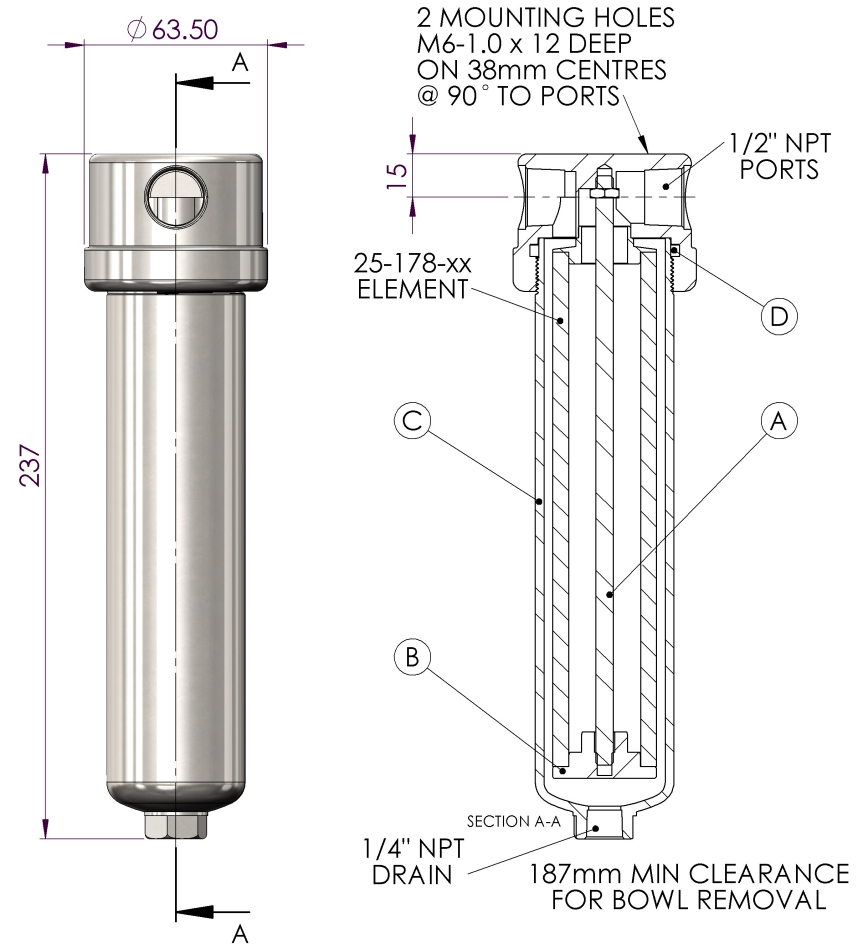

Please Note: Exotic Materials are available, for Alloy C-276 (142H) and for Alloy 400 (142M).

Headline Filters Limited Mill Hall Business Estate Aylesford Kent, ME20 7JZ www.headlinefilters.com info@headlinefilters.com	Model 142		THE COPYRIGHT OF THIS DRAWING IS RESERVED BY HEADLINE FILTERS. IT IS ISSUED ON CONDITION THAT IT IS NOT COPIED, REPRODUCED OR DISCLOSED TO A THIRD PARTY EITHER WHOLLY, OR IN PART WITHOUT CONSENT IN WRITING.
	Material: Head: 316L Stainless Steel Bowl: 316L Stainless Steel Internals: 316L Stainless Steel Standard Gasket / O-ring: Viton	Drain Type: 1/4" NPT Maximum Temperature: 200°C Maximum Pressure: 100 Bar Internal Volume: 265 cc Weight: 1.1kg	
DO NOT SCALE DRAWING IF IN DOUBT ASK	Drawing No. HF4/1264		